

IPv6 Routing Protocols

ISP Workshops



These materials are licensed under the Creative Commons Attribution-NonCommercial 4.0 International license (<http://creativecommons.org/licenses/by-nc/4.0/>)

Acknowledgements

- This material originated from the Cisco ISP/IXP Workshop Programme developed by Philip Smith & Barry Greene
- Use of these materials is encouraged as long as the source is fully acknowledged and this notice remains in place
- Bug fixes and improvements are welcomed
 - Please email *workshop (at) bgp4all.com*

Philip Smith

Agenda

- Enabling IPv6 Routing on Cisco IOS
- IPv6 Routing Protocols:
 - Static
 - RIPng
 - EIGRP
 - OSPFv3
 - IS-IS
 - BGP

Initial IPv6 Configuration for Cisco IOS



IPv6 Configuration on Cisco IOS

- ❑ To enable IPv6 Routing the following global commands are required:

```
Router(config)# ipv6 unicast-routing
```

- Also enable IPv6 CEF (not on by default):

```
Router(config)# ipv6 cef
```

- Also disable IPv6 Source Routing (enabled by default):

```
Router(config)# no ipv6 source-route
```

IPv6 Configuration

- ❑ To configure a global or unique-local IPv6 address the following interface command should be entered:

```
Router(config-if)# ipv6 address X:X..X:X/prefix
```

- ❑ To configure an EUI-64 based IPv6 address the following interface command should be entered:

```
Router(config-if)# ipv6 address X:X::/prefix eui-64
```

- EUI-64 is not helpful on a router and is not recommended

IPv6 Configuration

- If no global IPv6 address is required on an interface, yet it needs to carry IPv6 traffic:

- Enable IPv6 on that interface using:

```
Router(config-if)# ipv6 enable
```

- Which will result in a link-local IPv6 address being constructed automatically
- FE80:: is concatenated with the Interface ID to give:
 - FE80::interface-id
- Configuring an IPv6 address (whether global or unique-local) will also result in a link-local IPv6 address being created

IPv6 Configuration – Link Local

```
Router1# conf t
Router1(config)# no ipv6 source-route
Router1(config)# ipv6 unicast-routing
Router1(config)# ipv6 cef
Router1(config)# interface FastEthernet 0/0
Router1(config-int)# ipv6 enable
Router1(config-int)# ^Z
```

```
Router1#sh ipv6 interface fast 0/0
FastEthernet0/0 is up, line protocol is up
  IPv6 is enabled, link-local address is FE80::A8B9:C0FF:FE00:F11D
  No global unicast address is configured
  Joined group address(es):
    FE02::1
    FE02::2
    FE02::1:FE00:F11D
  MTU is 1500 bytes
  ICMP error messages limited to one every 100 milliseconds
  ICMP redirects are enabled
```

IPv6 Configuration – EUI64

```
Router1# conf t
Router1(config)# no ipv6 source-route
Router1(config)# ipv6 unicast-routing
Router1(config)# ipv6 cef
Router1(config)# interface FastEthernet 0/0
Router1(config-int)# ipv6 address 2001:db8::/64 eui
Router1(config-int)# ^Z
```

```
Router1#sh ipv6 interface fast 0/0
FastEthernet0/0 is up, line protocol is up
  IPv6 is enabled, link-local address is FE80::A8B9:C0FF:FE00:F11D
  Global unicast address(es):
    2001:DB8::A8B9:C0FF:FE00:F11D, subnet is 2001:DB8::/64 [EUI]
  Joined group address(es):
    FF02::1
    FF02::2
    FF02::1:FF00:F11D
  MTU is 1500 bytes
  ICMP error messages limited to one every 100 milliseconds
  ICMP redirects are enabled
```

IPv6 Configuration – Manual

```
Router1# conf t
Router1(config)# no ipv6 source-route
Router1(config)# ipv6 unicast-routing
Router1(config)# ipv6 cef
Router1(config)# interface FastEthernet 0/0
Router1(config-int)# ipv6 address 2001:db8::2/64
Router1(config-int)# ^Z
```

```
Router1#sh ipv6 int fast 0/0
FastEthernet0/0 is up, line protocol is up
  IPv6 is enabled, link-local address is FE80::A8B9:C0FF:FE00:F11D
  Global unicast address(es):
    2001:DB8::2, subnet is 2001:DB8::/64
  Joined group address(es):
    FF02::1
    FF02::2
    FF02::1:FF08:2
    FF02::1:FF00:F11D
  ICMP error messages limited to one every 100 milliseconds
  ICMP redirects are enabled
```

IPv6 Interface Configuration

Duplicate Address Detection

- If a point-to-point interface (e.g. POS, HSSI, Serial) is looped:

- Router sees its address by Solicited Node Multicast
- Duplicate Address Detection kicks in:

```
Aug 23 09:18:41.263: %IPV6_ND-6-DUPLICATE_INFO: DAD attempt detected for 2001:DB8:0:3:: on Serial1/1
```

- Interface automatically disabled for IPv6 traffic (IPv4 traffic is unaffected)
 - This has impact for backbone links (IPv6 traffic takes alternative path) and external peering links (IPv6 peering down, IPv4 peering okay)
- Workaround?
 - Monitoring!
 - Cisco IOS "down-when-looped" configuration

Routing Protocols



Static Routing

- Syntax is:

- `ipv6 route ipv6-prefix/prefix-length {ipv6-address | interface-type interface-number} [administrative-distance]`

- Static Route

```
ipv6 route 2001:DB8::/64 2001:DB8:2:1::1 150
```

- Routes packets for network 2001:db8::/64 to a networking device at 2001:DB8:2:1::1 with an administrative distance of 150

Default Route Example

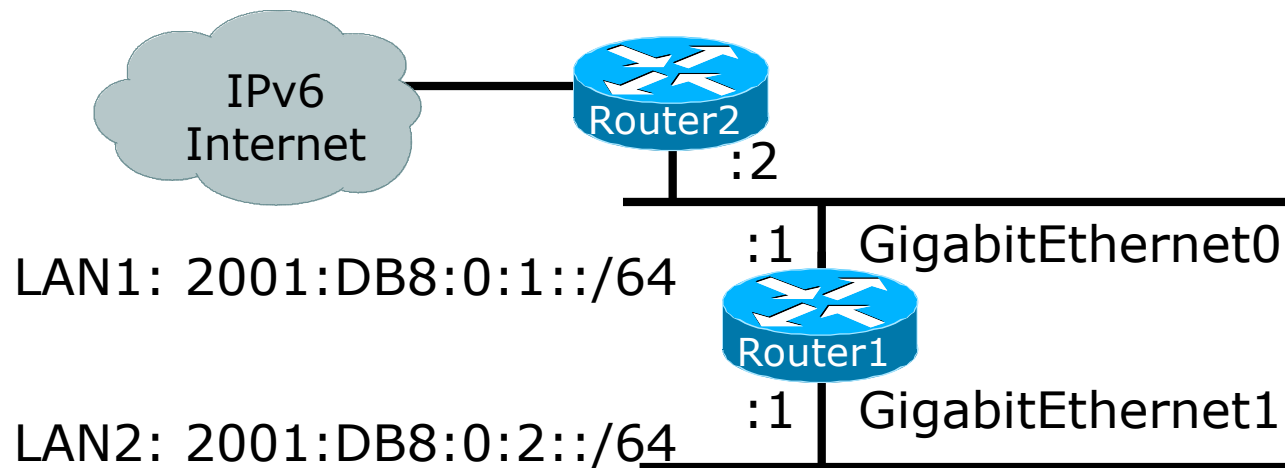

```
Router1# sh conf
<snip>
ipv6 unicast-routing
!
interface GigabitEthernet0
  ipv6 address 2001:DB8:0:1::1/64
!
interface GigabitEthernet1
  ipv6 address 2001:DB8:0:2::1/64
!
ipv6 route ::/0 2001:DB8:0:1::2
```

Default Route
to Router2

Dynamic Routing Protocols in IPv6

- Dynamic Routing in IPv6 is unchanged from IPv4:
 - IPv6 has 2 types of routing protocols: IGP and EGP
 - IPv6 still uses the longest-prefix match routing algorithm
- IGP
 - RIPng (RFC 2080)
 - Cisco EIGRP for IPv6
 - OSPFv3 (RFC 5340)
 - Integrated IS-ISv6 (RFC 5308)
- EGP
 - MP-BGP4 (RFC 4760 and RFC 2545)

Configuring Routing Protocols

- ❑ Dynamic routing protocols require a router-id
 - Router-id is a 32 bit integer unique to the router
 - IOS auto-generates these from loopback interface address if configured, else highest IPv4 address on the router
 - **Most ISPs will deploy IPv6 dual stack** – so router-id will be automatically created
- ❑ Early adopters choosing to deploy IPv6 in the total absence of any IPv4 addressing need to be aware:
 - Router-id needs to be manually configured:

```
ipv6 router ospf 100  
router-id 10.1.1.4
```

RIPng

- ❑ For the ISP industry, simply don't go here
- ❑ ISPs do not use RIP in any form unless there is absolutely no alternative
 - And there usually is
- ❑ RIPng was used in the early days of the IPv6 test network
 - Sensible routing protocols such as OSPF and BGP rapidly replaced RIPng when they became available

EIGRP for IPv6

- Cisco EIGRP has had IPv6 protocol support added
 - Just another protocol module (IP, IPX, AppleTalk) with three new TLVs:
 - IPv6_REQUEST_TYPE (0X0401)
 - IPv6_METRIC_TYPE (0X0402)
 - IPv6_EXTERIOR_TYPE (0X0403)
 - Router-ID is still 32-bit, protocol is still 88
- Uses similar CLI to existing IPv4 protocol support
- Easy deployment path for existing IPv4 EIGRP users
- In Cisco IOS Release 12.4 onwards

EIGRP for IPv6

- Some differences:
 - Hellos are sourced from the link-local address and destined to FF02::A (all EIGRP routers). This means that neighbors do not have to share the same global prefix (with the exception of explicitly specified neighbours where traffic is unicasted).
 - Automatic summarisation is disabled by default for IPv6 (unlike IPv4)
 - No split-horizon in the case of EIGRP for IPv6 (because IPv6 supports multiple prefixes per interface)

EIGRP for IPv6

Configuration & Display

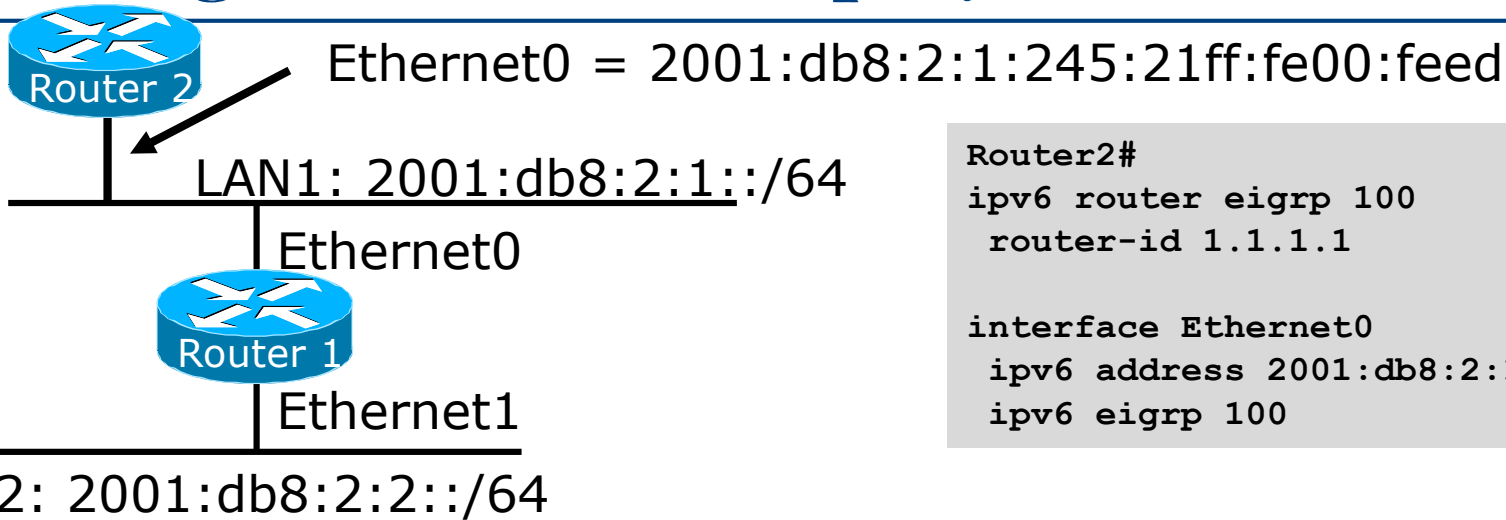

```
Router2#
ipv6 router eigrp 100
router-id 1.1.1.1

interface Ethernet0
ipv6 address 2001:db8:2:1::/64 eui-64
ipv6 eigrp 100
```

```
Router1#show ipv6 eigrp neighbor
IPv6-EIGRP neighbors for process 100
H Address                               Interface Hold    Uptime  SRTT  RTO    Q  Seq
                                (sec)  (sec)  (ms)                Cnt  Num
0 FE80::245:21ff:fe00:feed             E0        14 00:01:43    1 4500    0    1
```

```
Router1#show ipv6 eigrp topology all-links
IPv6-EIGRP Topology Table for AS(100)/ID(1.1.1.1)
Codes: P - Passive, A - Active, U - Update, Q - Query, R - Reply,
       r - reply Status, s - sia Status
P 2001:db8:2:1::/64, 1 successors, FD is 28160, serno 1
  via Connected, Ethernet0
    via FE80::245:21ff:fe00:feed (30720/28160), Ethernet0
```

Neighbour Identified by Link-Local Address

OSPFv3 overview

- ❑ OSPFv3 is OSPF for IPv6 (RFC 5340)
- ❑ Based on OSPFv2, with enhancements
- ❑ Distributes IPv6 prefixes
- ❑ Runs directly over IPv6
- ❑ Ships-in-the-night with OSPFv2

Differences from OSPFv2

- Runs over a link, not a subnet
 - Multiple instances per link
- Topology not IPv6 specific
 - Router ID
 - Link ID
- Standard authentication mechanisms
- Uses link local addresses
- Generalized flooding scope
- Two new LSA types

OSPFv3 configuration example

```
Router1#  
interface GigabitEthernet0  
  ipv6 address 2001:db8:1:1::1/64  
  ipv6 ospf 1 area 0  
!  
interface GigabitEthernet1  
  ipv6 address 2001:db8:1:2::1/64  
  ipv6 ospf 1 area 1  
!  
ipv6 router ospf 1  
  router-id 192.168.0.1
```

NB: Router-id only required in
absence of any IPv4 configuration

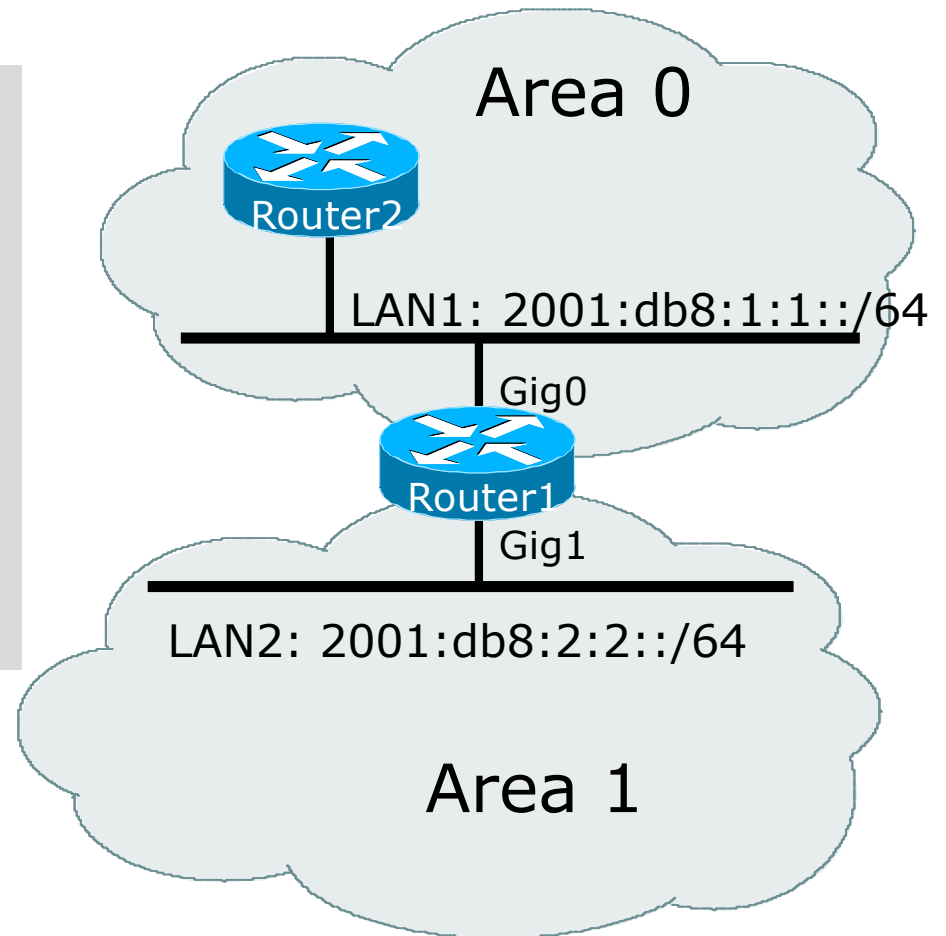

Dual stack OSPF configuration example

```
Router1#
interface GigabitEthernet0
 ip address 192.168.1.1 255.255.255.0
 ip ospf 1 area 0
 ipv6 address 2001:db8:1:1::1/64
 ipv6 ospf 1 area 0
!
interface GigabitEthernet1
 ip address 192.168.2.2 255.255.255.0
 ip ospf 1 area 1
 ipv6 address 2001:db8:1:2::1/64
 ipv6 ospf 1 area 1
!
router ospf 1
 passive-interface default
 no passive-interface GigabitEthernet0
 no passive-interface GigabitEthernet1
!
ipv6 router ospf 1
 passive-interface default
 no passive-interface GigabitEthernet0
 no passive-interface GigabitEthernet1
!
```

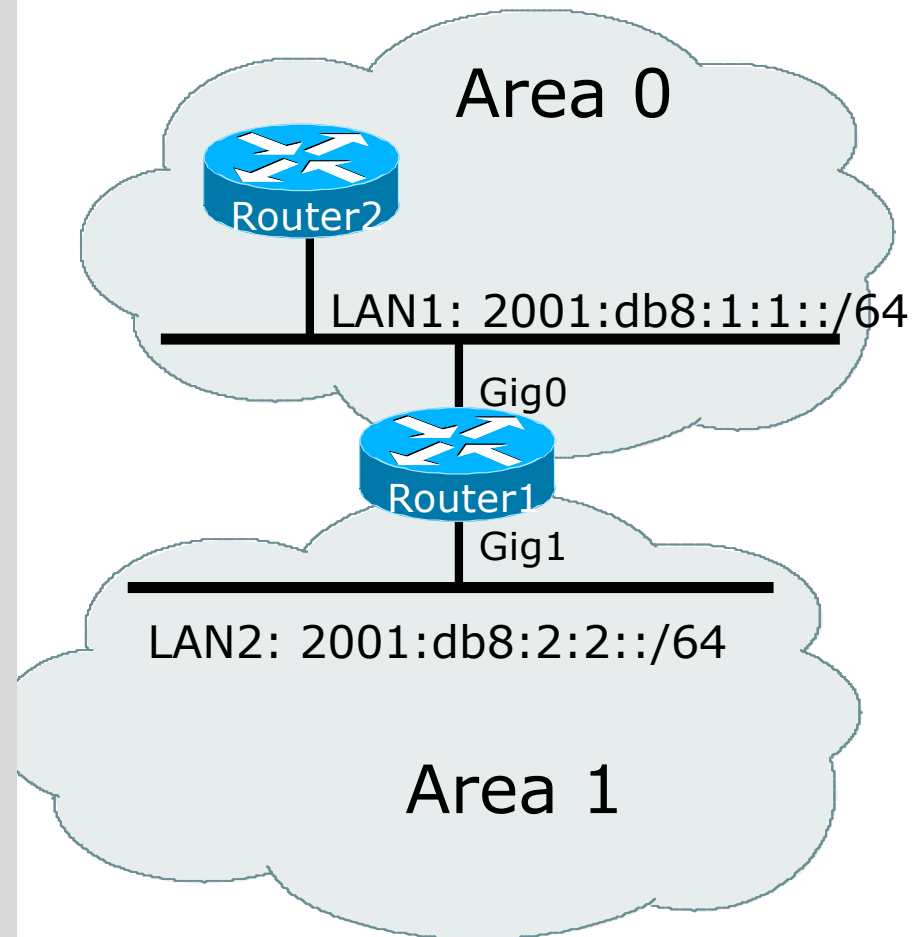

OSPFv3 entries in Routing Table

```
Router2#sh ipv6 route
IPv6 Routing Table - 5 entries
Codes: C - Connected, L - Local, S - Static, R - RIP, B - BGP
       U - Per-user Static route
       I1 - ISIS L1, I2 - ISIS L2, IA - ISIS interarea
       O - OSPF intra, OI - OSPF inter, OE1 - OSPF ext 1, OE2 - OSPF ext 2
OI 2001:DB8:FFFF:1::/64 [110/2]
   via FE80::2D0:FFFF:FE60:DFFF, POS3/0
C 2001:DB8:1:1::/64 [0/0]
  via ::, POS3/0
L 2001:DB8:1:1::1/128 [0/0]
  via ::, POS3/0
L FE80::/10 [0/0]
  via ::, Null0
L FF00::/8 [0/0]
  via ::, Null0
```

IS-IS Standards History

- ❑ ISO 10589 specifies the OSI IS-IS routing protocol for CLNS traffic
- ❑ RFC 1195 added IPv4 support
 - Also known as Integrated IS-IS (I/IS-IS)
 - I/IS-IS runs on top of the Data Link Layer
- ❑ RFC5308 adds IPv6 address family support
- ❑ RFC5120 defines Multi-Topology
 - Permits IPv4 and IPv6 topologies which are not identical
 - Permits roll out of IPv6 without impacting IPv4 operations

Cisco IOS IS-IS dual stack configuration

– single topology

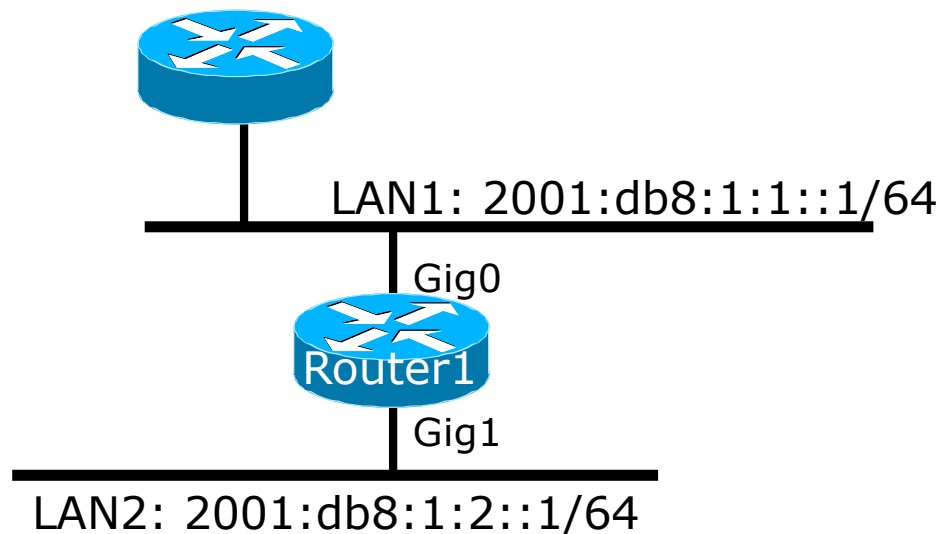

Dual stack IPv4/IPv6 single topology configuration.

```
Router1#
interface GigabitEthernet0
 ip address 192.168.1.1 255.255.255.0
 ip router isis
 ipv6 address 2001:db8:1:1::1/64
 ipv6 router isis
!
interface GigabitEthernet1
 ip address 192.168.2.1 255.255.255.0
 ip router isis
 ipv6 address 2001:db8:1:2::1/64
 ipv6 router isis
!
router isis
 net 42.0001.1921.6800.0001.00
 metric-style wide
!
```

Cisco IOS IS-IS dual stack configuration

– multi-topology

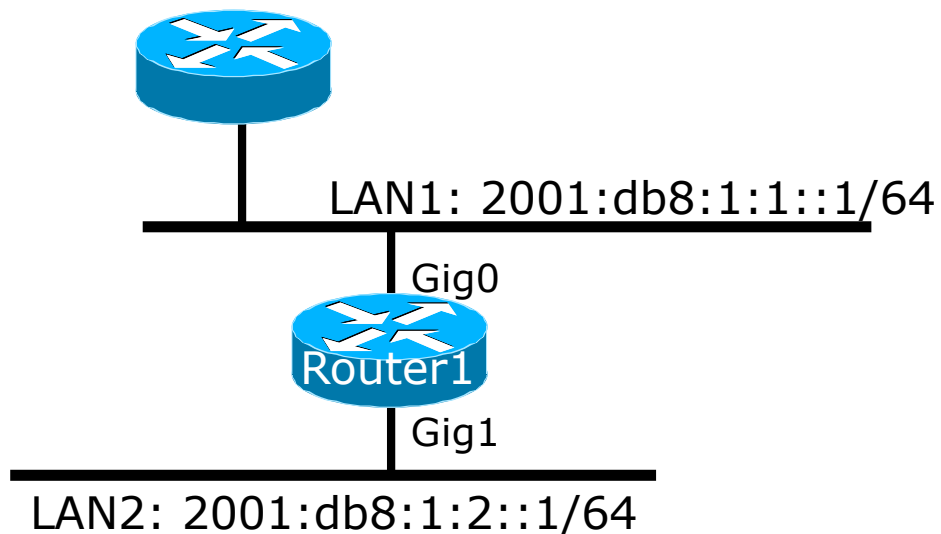

Dual stack IPv4/IPv6 multi-topology configuration.

```
Router1#
interface GigabitEthernet0
 ip address 192.168.1.1 255.255.255.0
 ip router isis
 ipv6 address 2001:db8:1:1::1/64
 ipv6 router isis
 !
interface GigabitEthernet1
 ip address 192.168.2.1 255.255.255.0
 ip router isis
 ipv6 address 2001:db8:1:2::1/64
 ipv6 router isis
 !
router isis
 net 42.0001.1921.6800.0001.00
 metric-style wide
 !
address-family ipv6
 multi-topology
 !
```

IS-IS entries in Routing Table

```
router1#sh ipv6 route isis
IPv6 Routing Table - default - 46 entries
Codes: C - Connected, L - Local, S - Static, U - Per-user Static route
       B - BGP, HA - Home Agent, MR - Mobile Router, R - RIP
       I1 - ISIS L1, I2 - ISIS L2, IA - ISIS interarea, IS - ISIS summary
       D - EIGRP, EX - EIGRP external, ND - Neighbor Discovery, I - LISP
       O - OSPF Intra, OI - OSPF Inter, OE1 - OSPF ext 1, OE2 - OSPF ext 2
       ON1 - OSPF NSSA ext 1, ON2 - OSPF NSSA ext 2

I2 2001:DB8::2/128 [115/2]
    via FE80::C801:3CFF:FE4F:8, FastEthernet0/0
I2 2001:DB8::3/128 [115/20]
    via FE80::C802:3CFF:FE4F:0, Serial1/0
I2 2001:DB8::4/128 [115/22]
    via FE80::C801:3CFF:FE4F:8, FastEthernet0/0
I2 2001:DB8::5/128 [115/40]
    via FE80::C802:3CFF:FE4F:0, Serial1/0
I2 2001:DB8::6/128 [115/42]
    via FE80::C801:3CFF:FE4F:8, FastEthernet0/0
    via FE80::C802:3CFF:FE4F:0, Serial1/0
```

Multi-Protocol BGP for IPv6 – RFC2545

- IPv6 specific extensions
 - Scoped addresses: Next-hop contains a global IPv6 address and/or potentially a link-local address
 - NEXT_HOP and NLRI are expressed as IPv6 addresses and prefix
 - Address Family Information (AFI) = 2 (IPv6)
 - Sub-AFI = 1 (NLRI is used for unicast)
 - Sub-AFI = 2 (NLRI is used for multicast RPF check)
 - Sub-AFI = 3 (NLRI is used for both unicast and multicast RPF check)
 - Sub-AFI = 4 (label)

Simple IPv6 BGP Session

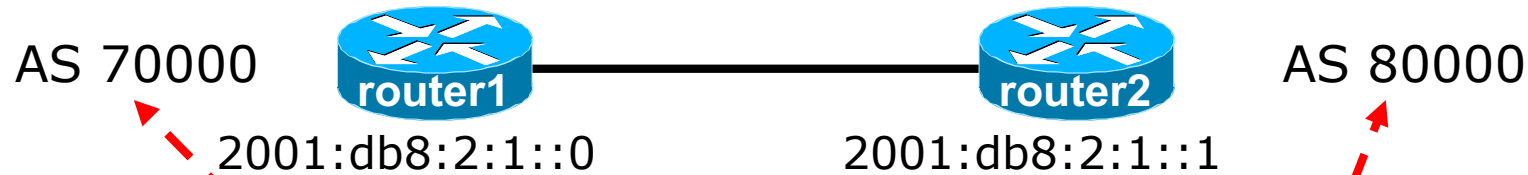

```
Router1#  
interface GigabitEthernet0  
  ipv6 address 2001:db8:2:1::/127  
!  
router bgp 70000  
  bgp router-id 192.168.0.1  
  no bgp default ipv4-unicast  
  neighbor 2001:db8:2:1::1 remote-as 80000  
  address-family ipv6  
    neighbor 2001:db8:2:1::1 activate  
    neighbor 2001:db8:2:1::1 prefix-list bgp80000in in  
    neighbor 2001:db8:2:1::1 prefix-list bgp80000out out  
  exit-address-family  
!
```

Dual Stack BGP Configuration



```
router bgp 70000
  no bgp default ipv4-unicast
  neighbor 2001:db8:2:1::1 remote-as 80000
  neighbor 172.16.1.2 remote-as 80000
  !
  address-family ipv4
    neighbor 172.16.1.2 activate
    neighbor 172.16.1.2 prefix-list ipv4-ebgp in
    neighbor 172.16.1.2 prefix-list v4out out
    network 172.16.0.0 mask 255.255.0.0
  exit-address-family
  !
  address-family ipv6
    neighbor 2001:db8:2:1::1 activate
    neighbor 2001:db8:2:1::1 prefix-list ipv6-ebgp in
    neighbor 2001:db8:2:1::1 prefix-list v6out out
    network 2001:db8::/32
  exit-address-family
  !
```

Routing Protocols for IPv6

Summary

- ❑ Support for IPv6 in the major routing protocols
- ❑ More details about OSPF, IS-IS and BGP in separate presentations

IPv6 Routing Protocols



ISP Workshops